

SPECIFICATION	CONNECTION	UNIPOLAR
VOTAGE(VOC)		12.00
AMPS/PHASE		0.40
RESISTANCE/PHASE(Ohms)@25°C		30.00±10%
INDUCTANCE/PHASE(mH)@1KHz		30.00±20%
HOLDING TORQUE(Nm)[lb-in]		0.26[2.30]
STEP ANGLE(°)		0.90
STEP ACCURACY(NON-ACCUM)		±5.00%
ROTOR INERTIA(g-cm <sup>2</sup> )		54.00
WEIGHT(Kg)[lb]		0.28[0.62]
TEMPERATURE RISE:MAX.80°C (MOTOR STANDSTILL;FOR 2PHASE ENERGIZED )		
AMBIENT TEMPERATURE -10°C~50°C[14°F~122°F]		
INSULATION RESISTANCE 100 Mohm (UNDER NORMAL TEMPERATURE AND HUMIDITY )		
INSULATION CLASS B 130°C[266°F]		
DIELECTRIC STRENGTH 500VAC FOR 1MIN.(BETWEEN THE MOTOR COILS AND THE MOTOR CASE )		
AMBIENT HUMIDITY MAX.85%(NO CONDENSATION)		

STEP	A	B	$\bar{A}$	$\bar{B}$	O( $\bar{O}$ )	CW
1	+	+			+	
2		+	+		+	
3			+	+	+	
4	+			+	+	
1	+	+			+	

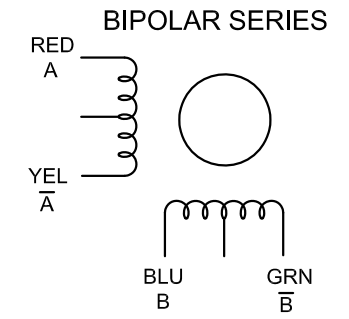
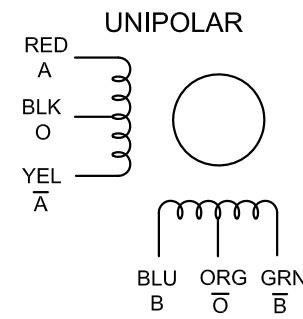

APVD		
CHKD		
1:1	DRN	
SCALE	SIGNATURE	DATE

**STEPPER MOTOR**

**17HM15-0406S**