

SPECIFICATION	CONNECTION	UNIPOLAR
VOTAGE(VOC)		12.00
AMPS/PHASE		0.40
RESISTANCE/PHASE(Ohms)@25°C		30.00±10%
INDUCTANCE/PHASE(mH)@1KHz		38.00±20%
HOLDING TORQUE(Nm)[lb-in]		0.32[2.83]
STEP ANGLE(°)		0.90
STEP ACCURACY(NON-ACCUM)		±5.00%
ROTOR INERTIA(g-cm ²)		68.00
WEIGHT(Kg)[lb]		0.35[0.77]
TEMPERATURE RISE:MAX.80°C (MOTOR STANDSTILL;FOR 2PHASE ENERGIZED)		
AMBIENT TEMPERATURE -10°C~50°C[14°F~122°F]		
INSULATION RESISTANCE 100 Mohm (UNDER NORMAL TEMPERATURE AND HUMIDITY)		
INSULATION CLASS B 130°C[266°F]		
DIELECTRIC STRENGTH 500VAC FOR 1MIN.(BETWEEN THE MOTOR COILS AND THE MOTOR CASE)		
AMBIENT HUMIDITY MAX.85%(NO CONDENSATION)		

STEP	A	B	\bar{A}	\bar{B}	O(\bar{O})	CW
1	+	+			+	
2		+	+		+	
3			+	+	+	
4	+			+	+	
1	+	+			+	

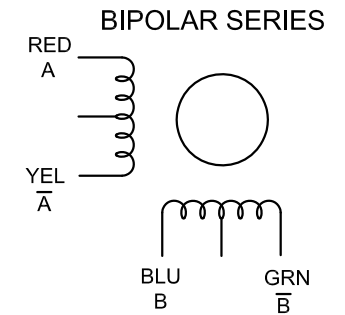
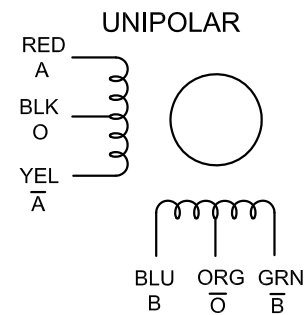

APVD		
CHKD		
1:1	DRN	
SCALE	SIGNATURE	DATE

STEPPER MOTOR

17HM19-0406S