

END COVER COLOR : BLACK

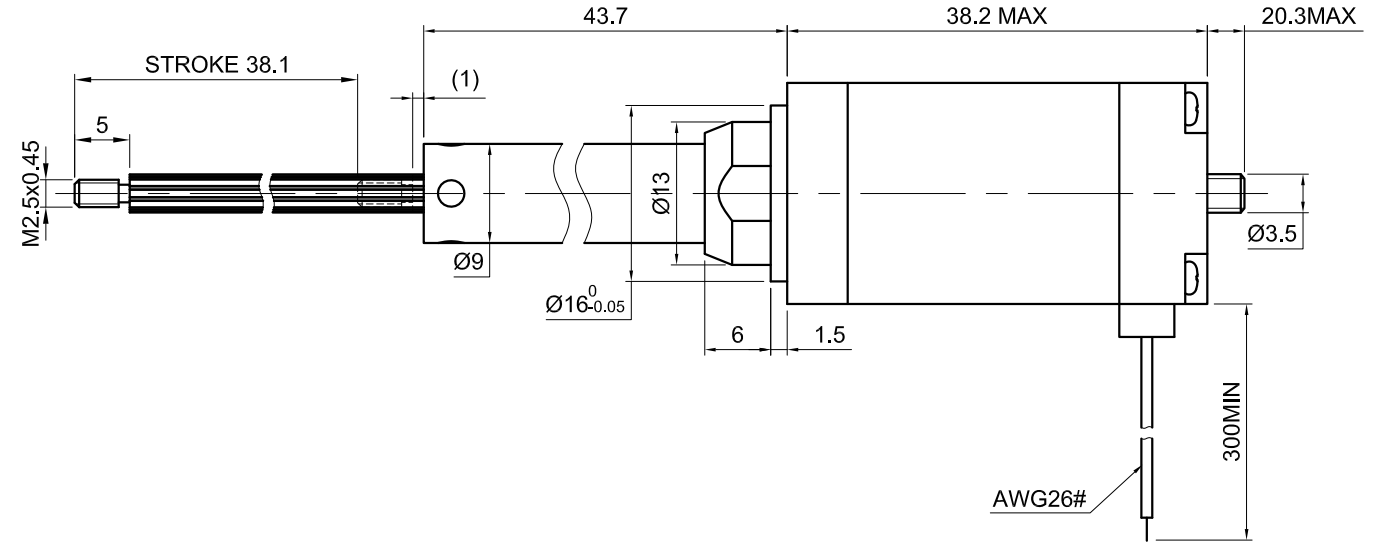
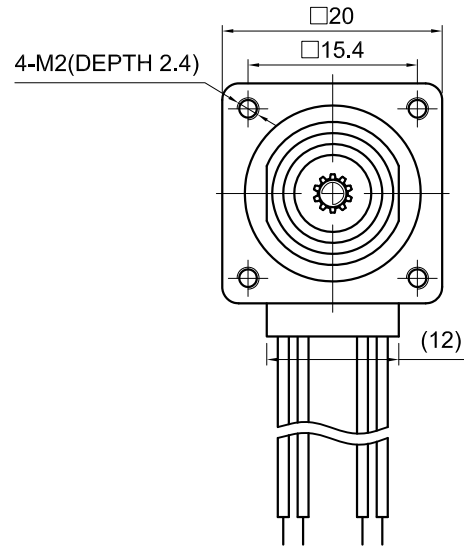

SPECIFICATION	CONNECTION	BIPOLAR
AMPS/PHASE		0.50
RESISTANCE/PHASE(Ohms)@25°C		12.00±10%
INDUCTANCE/PHASE(mH)@1KHz		4.50±20%
HOLDING TORQUE(Nm)[lb-in]		0.02[0.18]
LEAD(mm)		2
LINEAR TRAVEL/STEP(mm)		0.01
STEP ANGLE(°)		1.80
STEP ACCURACY(NON-ACCUM)		±5.00%
WEIGHT(Kg)[lb]		—

TEMPERATURE RISE:MAX.80°C (MOTOR STANDSTILL;FOR 2PHASE ENERGIZED)

AMBIENT TEMPERATURE -20°C~+50°C[-4°F~+122°F]

INSULATION RESISTANCE 100 Mohm (UNDER NORMAL TEMPERATURE AND HUMIDITY)

INSULATION CLASS B 130°C[266°F]

DIELECTRIC STRENGTH 500VAC FOR 1MIN.(BETWEEN THE MOTOR COILS AND THE MOTOR CASE)

TYPE OF CONNECTION (EXTERN)		MOTOR	
PIN NO	BIPOLAR	LEADS	WINDING
1	A+	RED	A+
2	A-	RED/WHT	A-
3	B+	GRN	B+
4	B-	GRN/WHT	B-

FULL STEP 2 PHASE-Ex. ,
WHEN FACING MOUNTING END (X)

STEP	A+	B+	A-	B-		CCW
1	+	+	-	-	↓ ↑	↑ ↓
2	-	+	+	-		
3	-	-	+	+		
4	+	-	-	+		

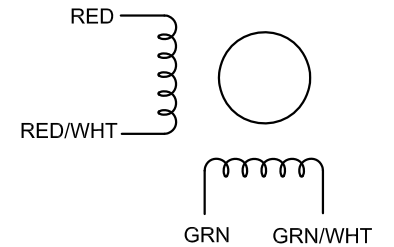

APVD		8.10.2022
CHKD		
1.5:1	DRN	
SCALE	SIGNATURE	DATE

STEPPER MOTOR

8C15S0504AC5-038RS