

SPECIFICATION	CONNECTION	BIPOLAR
AMPS/PHASE		4.20
RESISTANCE/PHASE(Ohms)@25°C		0.90±10%
INDUCTANCE/PHASE(mH)@1KHz		3.80±20%
HOLDING TORQUE(Nm)[lb-in]		3.00[26.55]
STEP ANGLE(°)		1.80
STEP ACCURACY(NON-ACCUM)		±5.00%
ROTOR INERTIA(g-cm²)		800.00
WEIGHT(Kg)[lb]		1.75[3.86]
TEMPERATURE RISE:MAX.80°C (MOTOR STANDSTILL;FOR 2PHASE ENERGIZED)		
AMBIENT TEMPERATURE -10°C~50°C[14°F~122°F]		
INSULATION RESISTANCE 100 Mohm (UNDER NORMAL TEMPERATURE AND HUMIDITY)		
INSULATION CLASS B 130°C[266°F]		
DIELECTRIC STRENGTH 500VAC FOR 1MIN.(BETWEEN THE MOTOR COILS AND THE MOTOR CASE)		
AMBIENT HUMIDITY MAX.85%(NO CONDENSATION)		

EXTERNAL POTENTIOMETER SPEED REGULATING CONNECTION

WARNING:NEVER SHORTEN Vr TO GND.
 WARNING:HOT PLUGGING IS FORBIDDEN.
 WARNING:ALL CONTROLLERS ,GAREWAYS AND SUBSCRIBER EQUIPMENTS MUST BE COMMONGROUNDED.

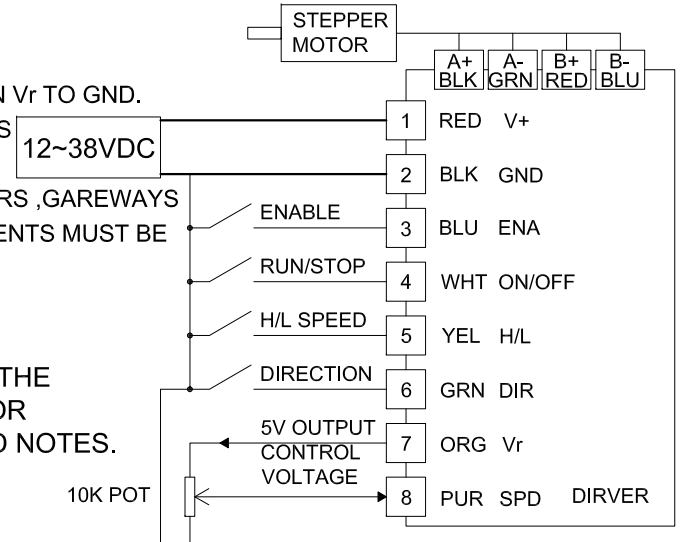

PLEASE REFER TO THE DRIVER MANUAL FOR OTHER WIRING AND NOTES.



APVD		7.18.2019
CHKD		
1:1.5	DRN	
SCALE	SIGNATURE	DATE

INTEGRATED STEPPER MOTOR
 ISC08-30