

**User's Manual**  
For  
**Integrated Servo Motor**  
**iSV Series**



**BLDC Servo Motor + Drive, 24-50VDC, Frame 57mm ,90W-180W**

## 1. Introduction

An iSV57T(S) servo motor is a NEMA23 (57mm) brushless motor integrated with a 16-bit magnetic encoder and servo driver, which making performance better and tuning easier. And the compact design saves installation space, eliminates encoder and motor wiring time, reduces interference and costs.

## 2. Specifications

Parameter	Min	Typical	Max	Unit
Input Voltage	20	36	50	VDC
Continuous Current	0	-	6.0	A
Pulse Input Frequency	0	-	300	kHz
Pulse Voltage	0	5	5	V
Logic Signal Current	7	10	16	mA
Isolation Resistance	100	-	-	MΩ

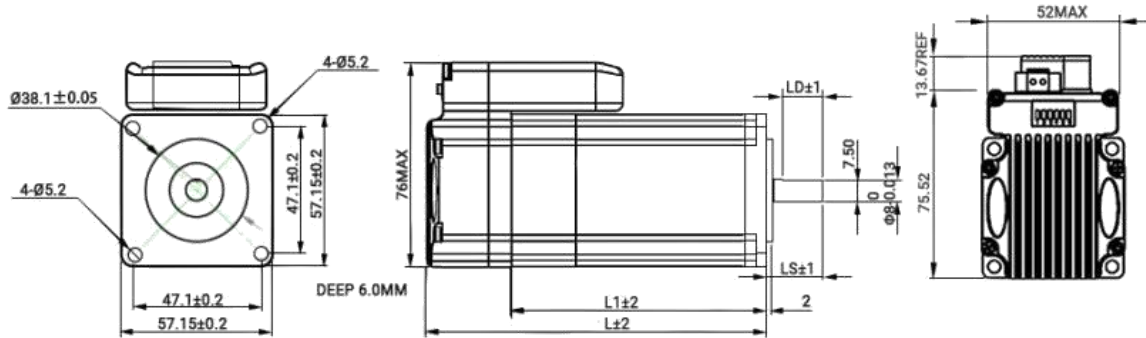

Part Number	iSV57T-090(S)	iSV57T-130(S)	iSV57T-180(S)
Rated Power(W)	90	130	180
Rated Torque (N.m)	0.3	0.4	0.6
Peak Torque(N.m)	0.9	1.2	1.8
Rated Speed(rpm)	3000	3000	3000
Peak Speed(rpm)	4000	4000	4000
Rated Voltage(Vdc)	36	36	36
Rotor Inertia(g-cm <sup>2</sup> )	264	394	524
Weight(kg)	0.95	1.25	1.54
L1(mm)	76	96	116
L(mm)	108	128	148
LS(mm)	33(21)	33(21)	33(21)
LD(mm)	27(15)	27(15)	27(15)

## 3.Connectors and Pin Assignment

Control Signal Connector			
Pin	Name	I/O	Description
1	PUL+	I	Pulse signal: Pulse active at rising edge; 4-5V when PUL-HIGH, 0-0.5V when PUL-LOW. Minimal pulse width of 2.5 $\mu$ s. It's recommend dutycycle 50%. Add a resistor for current-limiting at +12V or +24V input logic voltage (1K for +12V, 2k for +24V).
2	PUL-	I	
3	DIR+	I	DIR signal: Pulse active at rising edge; 4-5V when PUL-HIGH, 0-0.5V when PUL-LOW. The low/high voltage levels to represent two directions of motor rotation. Add a resistor for current-limiting at +12V or +24V input logic voltage (1K for +12V, 2k for +24V). The DIR signal at least 5 $\mu$ s in advance of PUL signal
4	DIR-	I	
5	ALM+	O	Alarm Signal: OC output signal, activated when one of the following protection is activated: over-voltage and over current error. They can sink or source MAX 50mA current at 24V. By default, the impedance between ALM+ and ALM- is low for normal operation and becomes high when any protection is activated. The active impedance of alarm signal is software configurable.
6	ALM-	O	

Note : The enable signal is not configurable,it is enabled on power-up by default, and cannot be modified by software.

Power Connector			
Pin	Name	I/O	Description
1	+Vdc	I	Power Supply Input (Positive) 24-36VDC recommended. Please leave reasonable reservation for voltage fluctuation and back-EMF during deceleration.
2	GND	GND	Power Ground (Negative)

RS232 Communication Connector			
Pin	Name	I/O	Description
1	+5V	O	+5V power output ( Note: Do not connect it to PC's serial port)
2	TxD	O	RS232 transmit.
3	GND	GND	Ground.
4	RxD	I	RS232 receive.
5	NC	-	Not connected.

## 4. DIP Switch

### 4.1 Microstep (S1-S3)

Pulse/rev	S1	S2	S3
Pr0.08	off	off	off
1600	on	off	off
2000	off	on	off
3200	on	on	off
4000	off	off	on
5000	on	off	on
6400	off	on	on
8000	on	on	on

### 4.2 Stiffness Setting(S4-S5)

Stiffness	S4	S5
Pr0.03	off	off
9	on	off
10	off	on
11	on	on

### 4.3 Motor Direction (S6)

The DIP switch S6 is used to change the initial direction of the motor (offline), not as a real-time operation to modify the direction. Online modification of the motor direction is via the DIR signal

S6	Direction
off	CCW
on	CW

## 5. Typical Connections

### 5.1 Control Signal Connection

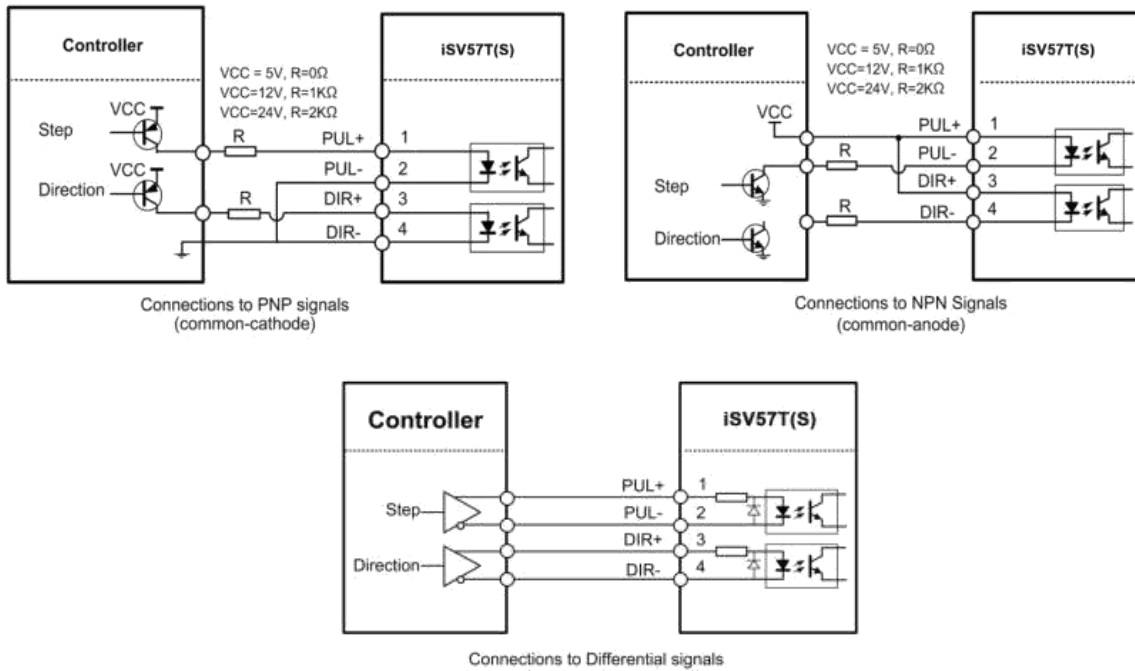

### 5.2 Alarm Output Connection

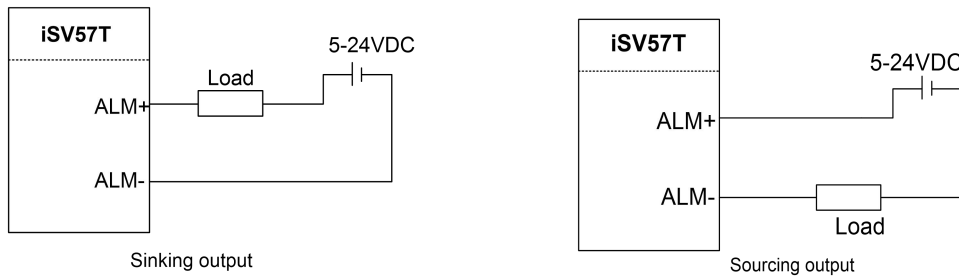

## 6. Quick Setting of Parameters

### 6.1 Connect to Tuning Software

When you open the "communication" window, just select the correct COM port and keep the default for other else, like this baud-rate, keep the default 38400, no need to change it to 19200

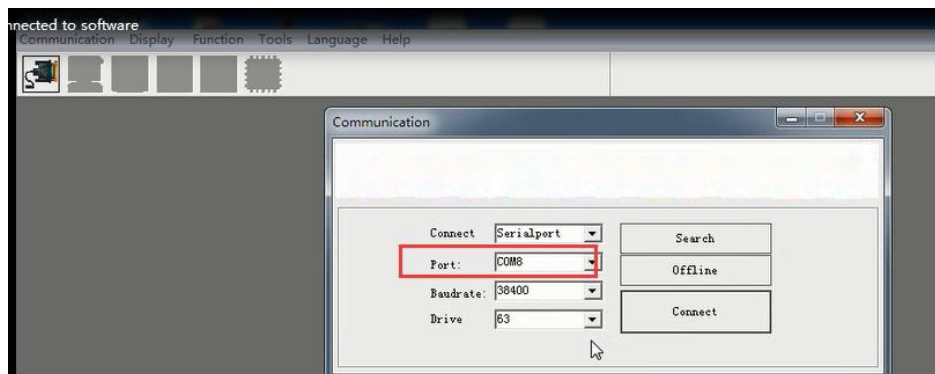

### 6.2 Key Parameters

Usually the setting for Pr0.01-0.04 and Pr2.22 can be :

Pr0.01 = 0; Pr0.02 = 1; Pr0.03 = 10 – 15; Pr0.04 = 100 – 1000; Pr2.22 is for smooth movement

Pr0.01	Control Mode Setup	Range	unit	default
		0-10	-	0

0: Position Control Mode;  
1-10: Unsupported Control Modes;

Pr0.02	Real-time Auto-gain Tuning	Range	unit	default
		0-2	-	1

You can set up the action mode of the real-time auto-gain tuning.

Setup value	Mode	Varying degree of load inertia in motion
0	Invalid	Real-time auto-gain tuning function is disabled.
1	Interpolation motion	Used for interpolation motion, such as CNC, engraving machine, etc.
2	Point-to-point motion	Mainly used for point-to-point movement

Note: If Pr0.02=1 or 2, the values of Pr1.01 – Pr1.13 are all read only, they are automatically generated.

Pr0.03	Stiffness	Range	unit	default
		0-31	-	11

It can be set by S4 and S5. If they are “off & off”. Screw-coupling load recommended stiffness range 10~14; pulley load recommended stiffness range 9~13. It is recommended to set a suitable value of Pr0.04 first, and then adjust the stiffness value.

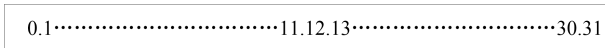
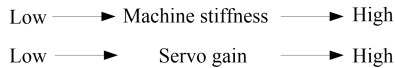

Note: Higher the setup value, higher the velocity response and servo stiffness will be obtained. However, when increasing the value, need to avoid oscillation or vibration.

Pr0.04	Load inertia ratio	Range	unit	default
		0-10000	%	300

It means that the ratio of load inertia against the motor rotor inertia. Recommended below 1000;

$$\text{Pr0.04} = (\text{load inertia} / \text{rotor inertia}) \times 100\%$$

If the value of inertia ratio is set correctly, the unit of Pr1.01 and Pr1.06 will change to “Hz”. If this value is too small, the motor will stop unstably, if the value is larger than the actual, the motor will shake when running,. How to get the correct value can be referred to Appendix A

Pr0.08	Microstep	Range	unit	default
		0-32767	pulse	4000

The number of pulses required for one revolution of the motor.

For some special users, it can use Pr0.09 (1<sup>st</sup> numerator of electronic gear) and Pr0.10 (Denominator of electronic Gear) to set required pulses number, they are available when Pr0.08 is set to value 0.

Pr2.22	Positional Command Smoothing Filter	Range	unit	default
		0-32767	0.1ms	0

- Set up the time constant of the 1<sup>st</sup> delay filter in response to the positional command.
- When a square wave command for the target speed  $V_c$  is applied, set up the time constant of the 1<sup>st</sup> delay filter as shown in the figure below.

Note: Restart the power to make new value available.

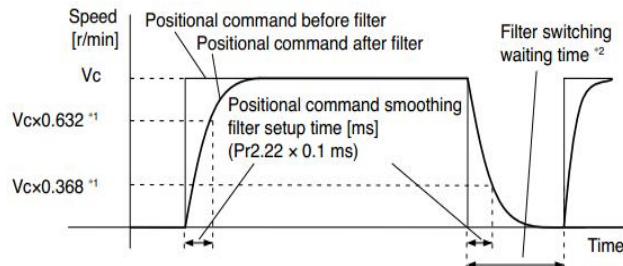

### 6.3 Save Parameters

If you want the modified parameters continue to be valid after power off, please click both “Download” and “Save”.





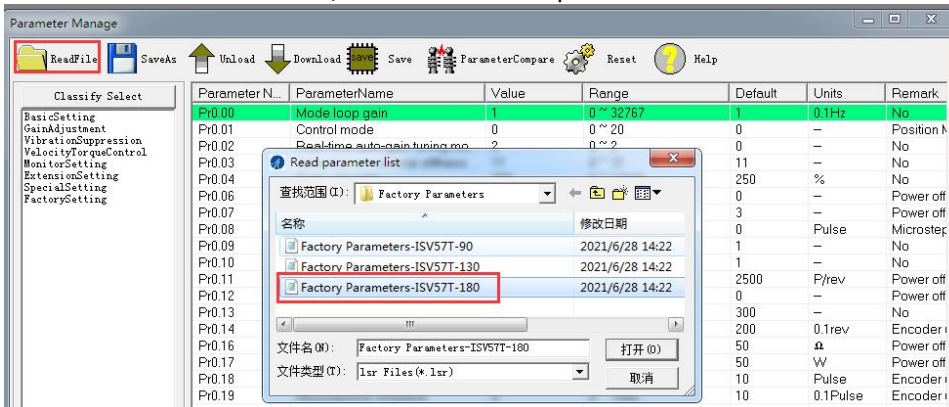

### 6.4 Restore to Factory

If you need to restore the factory settings, it can import the file with our factory parameter values, and then click both “Download” and “Save”, then valid after re-power.

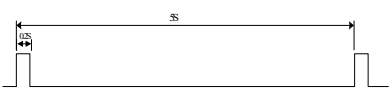
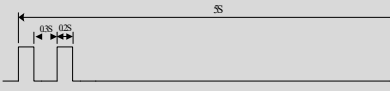

## 7. Fault Protections & Troubleshooting

To improve reliability, the drive incorporates some built-in protection features.

Blink time(s)	Sequence wave of red LED	Description	Trouble shooting
1		Over-current	Turn off the power immediately. a) Check if the machinery is stuck; b) Re-import factory parameters.
2		Over-voltage	Turn off the power immediately. a) Check if the power supply is below 50V, default over-voltage point is 72VDC
4		Over-load	Turn off the power immediately. c) Check if the machinery is stuck; a) Re-import factory parameters.
5		Encoder error	Restart the power supply, if the drive is still alarm, please contact after-sale
7		Position following error	a) Motor torque is not enough; b) Check if the machinery is stuck; c) Re-import factory parameters.

When above protections are active, the motor shaft will be free and the red LED blinks. Reset the drive by repowering it to make it function properly after removing above problems.

## Appendix A. How to get the correct Load inertia ratio

Load inertia ratio is a very important parameter for iSV57T(S) servo, and users need to set the correct load inertia ratio parameter before adjusting the correct rigidity parameter. Then the setup steps are as follows:

*Note: Do make the axis can be moved in safe distance, any interference should be avoided to ensure safety and accuracy of testing .*

(1) Connect motor with load, if there is no load, the value of load inertia ratio will be set to "0".

(2) Click "run test" , motor motion parameters and operating procedures are as follows:

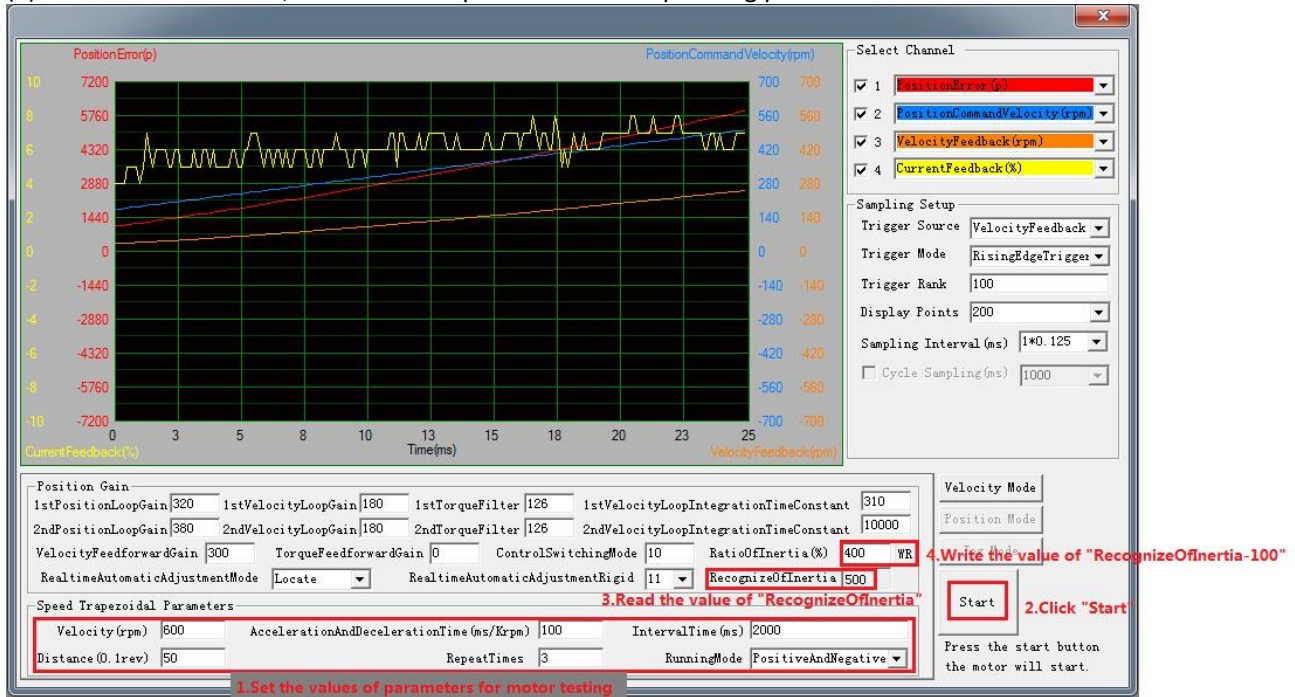

The screenshot shows the motor control software interface. The top part features a graph with four data series: PositionError(p) (red), PositionCommandVelocity(rpm) (blue), VelocityFeedback(rpm) (orange), and CurrentFeedback(%) (yellow). The x-axis represents Time(ms) from 0 to 25. The y-axes represent PositionError(p) from -10 to 10, PositionCommandVelocity(rpm) from -700 to 700, VelocityFeedback(rpm) from -700 to 700, and CurrentFeedback(%) from -10 to 10.

Below the graph are several parameter settings:

- Position Gain:** 1stPositionLoopGain: 320, 1stVelocityLoopGain: 180, 1stTorqueFilter: 126, 1stVelocityLoopIntegrationTimeConstant: 310, 2ndPositionLoopGain: 380, 2ndVelocityLoopGain: 180, 2ndTorqueFilter: 126, 2ndVelocityLoopIntegrationTimeConstant: 10000.
- Velocity Mode:** Velocity Mode selected.
- RatioOfInertia (%):** 400 (WR) - **4. Write the value of "RecognizeOfInertia-100"**
- RecognizeOfInertia:** 500 - **3. Read the value of "RecognizeOfInertia"**
- Speed Trapezoidal Parameters:** Velocity (rpm): 600, AccelerationAndDecelerationTime (ms/Krpm): 100, IntervalTime (ms): 2000, Distance (0.1rev): 50, RepeatTimes: 3, RunningMode: PositiveAndNegative.
- Buttons:** Start - **2. Click "Start"**

Additional settings include: Velocity Feedforward Gain: 300, Torque Feedforward Gain: 0, Control Switching Mode: 10, Realtime Automatic Adjustment Mode: Locate, Realtime Automatic Adjustment Rigid: 11, Cycle Sampling (ms): 1000.

The value of the load inertia ratio obtained from the above steps can satisfy most applications, but for some cases where the load inertia is very high, the value of Pr0.04 can be increased to more than 1000.

## Appendix B. Parameters List

The screenshot of the parameter list is provided for reference only. The figure is the factory parameter value of 180W integrated servo motor, because there are three motor models in this series, so the default parameters may not be the same.

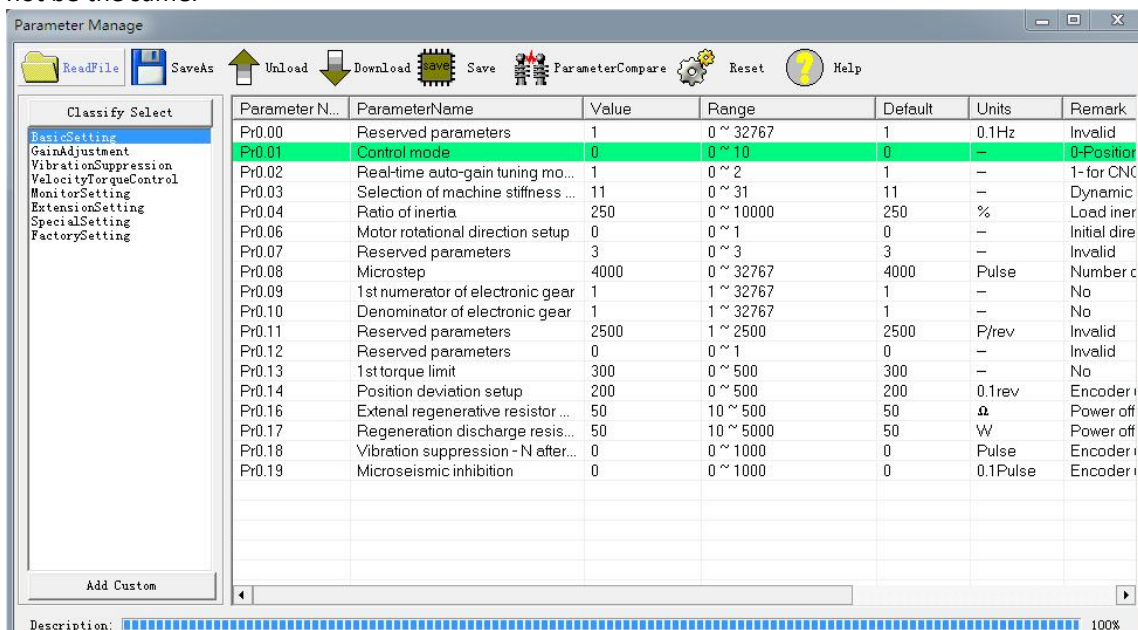

Parameter N...	ParameterName	Value	Range	Default	Units	Remark
Pr0.00	Reserved parameters	1	0 ~ 32767	1	0.1Hz	Invalid
Pr0.01	Control mode	0	0 ~ 10	0	-	0-Position
Pr0.02	Real-time auto-gain tuning mo...	1	0 ~ 2	1	-	1- for CNC
Pr0.03	Selection of machine stiffness ...	11	0 ~ 31	11	-	Dynamic
Pr0.04	Ratio of inertia	250	0 ~ 10000	250	%	Load iner
Pr0.06	Motor rotational direction setup	0	0 ~ 1	0	-	Initial dire
Pr0.07	Reserved parameters	3	0 ~ 3	3	-	Invalid
Pr0.08	Microstep	4000	0 ~ 32767	4000	Pulse	Number c
Pr0.09	1st numerator of electronic gear	1	1 ~ 32767	1	-	No
Pr0.10	Denominator of electronic gear	1	1 ~ 32767	1	-	No
Pr0.11	Reserved parameters	2500	1 ~ 2500	2500	P/rev	Invalid
Pr0.12	Reserved parameters	0	0 ~ 1	0	-	Invalid
Pr0.13	1st torque limit	300	0 ~ 500	300	-	No
Pr0.14	Position deviation setup	200	0 ~ 500	200	0.1rev	Encoder r
Pr0.16	External regenerative resistor ...	50	10 ~ 500	50	Ω	Power off
Pr0.17	Regeneration discharge resis...	50	10 ~ 5000	50	W	Power off
Pr0.18	Vibration suppression - N after...	0	0 ~ 1000	0	Pulse	Encoder r
Pr0.19	Microseismic inhibition	0	0 ~ 1000	0	0.1Pulse	Encoder r

Classify Select	Parameter N...	ParameterName	Value	Range	Default	Units	Remark
BasicSetting	Pr1.00	1st position loop gain	320	0 ~ 30000	320	0.1/s	No
GainAdjustment	Pr1.01	1st velocity loop gain	180	1 ~ 32767	180	0.1Hz	No
VibrationSuppression	Pr1.02	1st time constant of velocity lo...	310	1 ~ 10000	310	0.1ms	No
VelocityTorqueControl	Pr1.03	1st filter of velocity detection	8	0 ~ 10000	15	-	No
MonitorSetting	Pr1.04	1st torque filter	126	0 ~ 2500	126	0.01ms	No
ExtensionSetting	Pr1.05	2nd position loop gain	380	0 ~ 30000	380	0.1/s	No
SpecialSetting	Pr1.06	2nd velocity loop gain	180	1 ~ 32767	180	0.1Hz	No
FactorySetting	Pr1.07	2nd time constant of velocity l...	10000	1 ~ 10000	10000	0.1ms	No
	Pr1.08	2nd filter of velocity detection	8	0 ~ 31	15	-	No
	Pr1.09	2nd torque filter	126	0 ~ 2500	126	0.01ms	No
	Pr1.10	Velocity feed forward gain	300	0 ~ 1000	300	0.10%	No
	Pr1.11	Velocity feed forward filter	50	0 ~ 6400	50	0.01ms	No
	Pr1.12	Torque feed forward gain	0	0 ~ 1000	0	0.10%	No
	Pr1.13	Torque feed forward filter	0	0 ~ 6400	0	0.01ms	No
	Pr1.14	2nd gain setup	1	0 ~ 1	1	-	No
	Pr1.15	Control switching mode	0	0 ~ 10	0	-	No
	Pr1.17	Control switching level	50	0 ~ 20000	50	mode	No
	Pr1.18	Control switch hysteresis	33	0 ~ 20000	33	mode	No
	Pr1.19	Gain switching time	33	0 ~ 10000	33	0.1ms	No
	Pr1.33	Speed given filter	0	0 ~ 10000	0	0.01ms	No
	Pr1.35	Position command digital filter...	0	0 ~ 200	0	50ns	Power off
	Pr1.36	Encoder feedback pulse digit...	0	0 ~ 200	0	50ns	Power off
	Pr1.37	Special function register	0	0 ~ 32767	0	-	No
Add Custom							

Classify Select	Parameter N...	ParameterName	Value	Range	Default	Units	Remark
BasicSetting	Pr2.01	1st notch frequency	2000	50 ~ 2000	2000	Hz	No
GainAdjustment	Pr2.02	1st notch width	2	0 ~ 20	2	-	No
VibrationSuppression	Pr2.03	1st notch depth	0	0 ~ 99	0	-	No
VelocityTorqueControl	Pr2.04	2nd notch frequency	2000	50 ~ 2000	2000	Hz	No
MonitorSetting	Pr2.05	2nd notch width	2	0 ~ 20	2	-	No
ExtensionSetting	Pr2.06	2nd notch depth	0	0 ~ 99	0	-	No
SpecialSetting	Pr2.22	Positional command smoothin...	0	0 ~ 32767	0	0.1ms	Internal e
FactorySetting	Pr2.23	Positional command FIR filter	0	0 ~ 5000	0	0.1ms	No